

## Arvada™ F-529-7ARV

Pull-Down Kitchen Faucet  
Grifo Con Ducha Desmontable Para La Cocina  
Robinet de Cuisine avec Douche Amovible

## Quick Installation Guide Guía de Instalación Rápida Guide d'Installation Rapide

Installation Support • Soporte de Instalación • Support d'Installation

### Personal Assistance, Product Specs, & "How-to" Questions:

Asistencia personal, especificaciones del producto y preguntas sobre "cómo hacerlo":

Aide personnelle, spécifications du produit et questions « pratico-pratiques » :

**1-800-PFAUCET (732-8238)**

**pfisterfaucets.com/support**

Installation Videos Available  
Videos de instalación a disposición  
Vidéos d'installation disponibles



pfisterfaucets.com/videos



### WARNING / ADVERTENCIA / AVERTISSEMENT

To reduce the risk of injury or property damage, read all instructions before installing product. Wear safety goggles. Product must be installed in accordance with all state & local plumbing & building codes. Call a professional if you are uncertain about installing this product.

Para disminuir el riesgo de lesiones o daños a la propiedad, lea todas las instrucciones antes de instalar el producto. Utilice gafas de seguridad. El producto deberá instalarse de acuerdo con la normativa de plomería y construcción estatal y local. Llame a un profesional si no está seguro sobre cómo instalar este producto.

Pour réduire le risque de blessures ou de dommages, lire toutes les instructions avant d'installer le produit. Portez des lunettes de sécurité. Il faut installer le produit en respectant tous les codes de construction et de plomberie locaux et d'état. Appelez un professionnel si vous n'êtes pas certain de la façon d'installer ce produit.

### Required Tools

Herramientas necesarias  
Outils nécessaires



Adjustable Wrench  
Llave ajustable  
Clé réglable



Safety Goggles  
Gafas de seguridad  
Lunettes de sécurité

### Additional Helpful Tools

Otras herramientas útiles  
Outils supplémentaires utiles

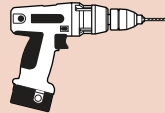

Power Drill  
Taladro Eléctrico  
Foreuse Électrique

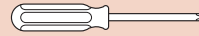

Phillips Screwdriver  
Destornillador de estrella  
Tournevis Phillips

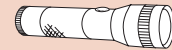

Flashlight  
Linterna  
Lampe De Poche



Cloth  
Paño  
Chiffon

### Parts in the Box

Piezas en la caja  
Pièces dans la boîte

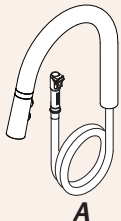

A



B

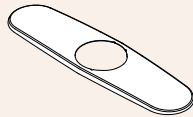

C

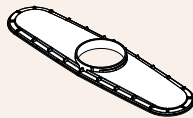

D



E



F

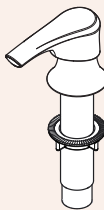

G

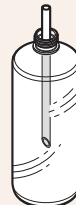

H



Aerator Tool  
Herramienta para el aireador  
Outil d'aérateur

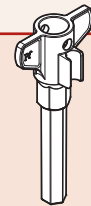

**Install Tool**



3/8 Socket Adapter  
Adaptador de zócalo 3/8  
Adaptateur de prise 3/8

‡ Store in a safe place  
‡ Almacenar en un lugar seguro  
‡ Conserver dans un endroit sûr

1

## Turn Off Water Supply • Cierre el suministro de agua • Couper l'alimentation en eau



Locate water supply inlets and shut off the water supply valves. These are usually found under the sink or near the water meter. If you are replacing an existing faucet, remove the old faucet from the sink and clean the sink surface thoroughly.

Ubique las entradas del suministro de agua y cierre las válvulas de suministro de agua. Generalmente se encuentran debajo del fregadero o cerca del medidor de agua. Si se trata de un reemplazo de grifo, quite el grifo viejo y limpie completamente la superficie del fregadero.

Recherchez les entrées d'approvisionnement et fermer leurs robinets. Ces robinets se trouvent généralement sous l'évier ou près du compteur d'eau. Si vous remplacez un robinet existant, retirez, le vieux robinet et nettoyer soigneusement la surface de l'évier.

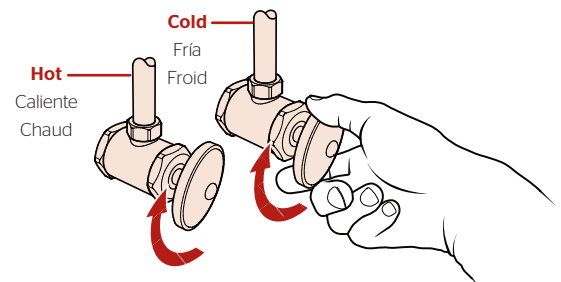

## 2

### Install Spout Body

Instale el cuerpo del surtidor

Installez le corps du bec

No Tools Required for This Step  
No se necesitan herramientas para este paso  
Pas d'outil nécessaire pour cette étape

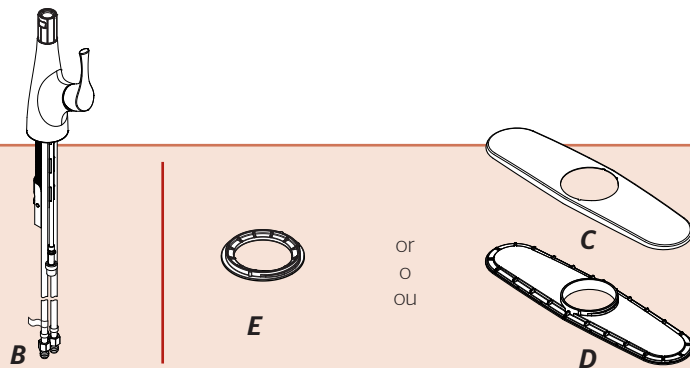

#### OPTION 1: Install Spout Body *without Deckplate*

OPCIÓN 1: Instale el surtidor sin la placa de cubierta

OPTION 1: Installation du bec sans la plaque de couverture

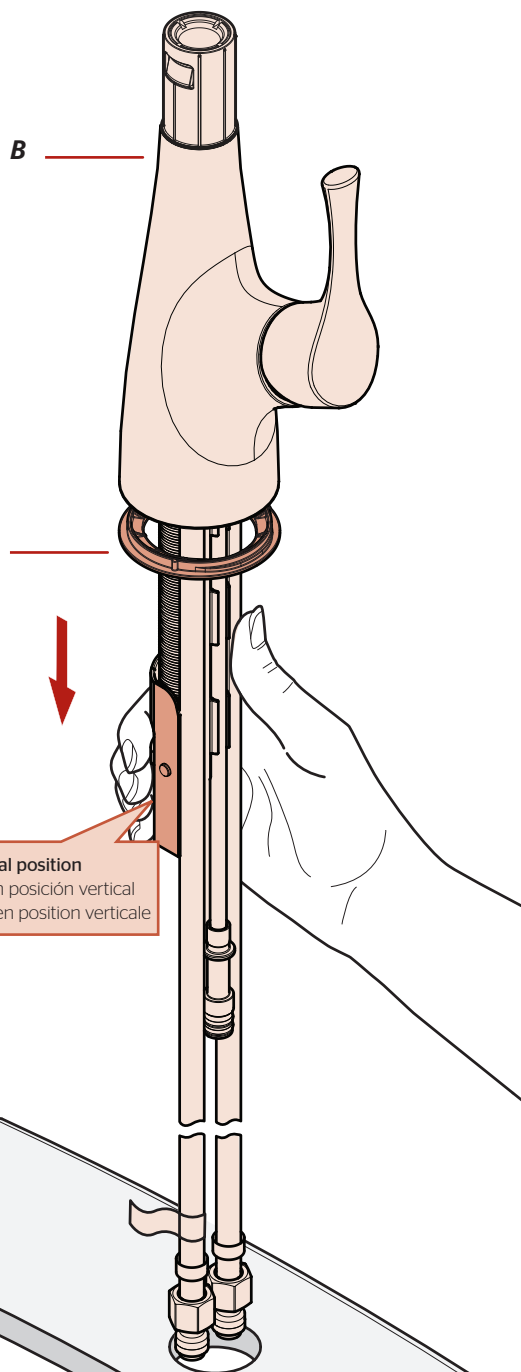
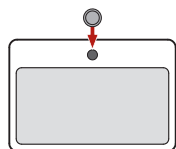

**!** Hold bracket in vertical position  
Sostenga el soporte en posición vertical  
Maintenez le support en position verticale

#### OPTION 2: Install Spout Body *with Deckplate*

OPCIÓN 2: Instale el surtidor con la placa de cubierta

OPTION 2: Installation du bec avec la plaque de couverture

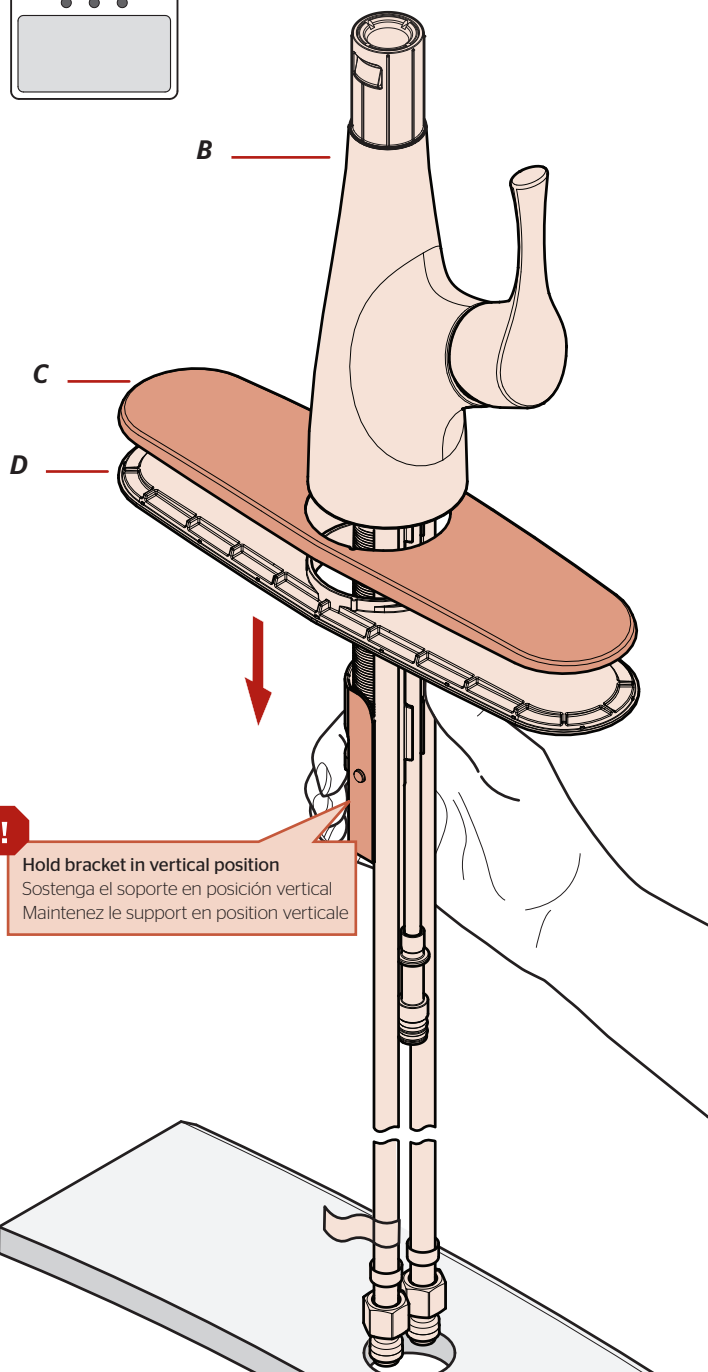
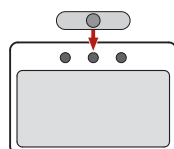

**!** Hold bracket in vertical position  
Sostenga el soporte en posición vertical  
Maintenez le support en position verticale

# 3

## Tighten Spout Body Apriete el cuerpo del surtidor Serrez le corps du bec

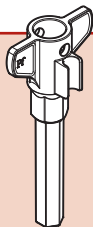

Install Tool

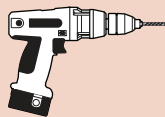

Power Drill  
Taladro Eléctrico  
Foreuse Électrique



3/8 Socket Adapter  
Adaptador de zócalo 3/8  
Adaptateur de prise 3/8



Phillips Screwdriver  
Destornillador de estrella  
Tournevis Phillips

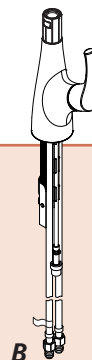

B

### 3A

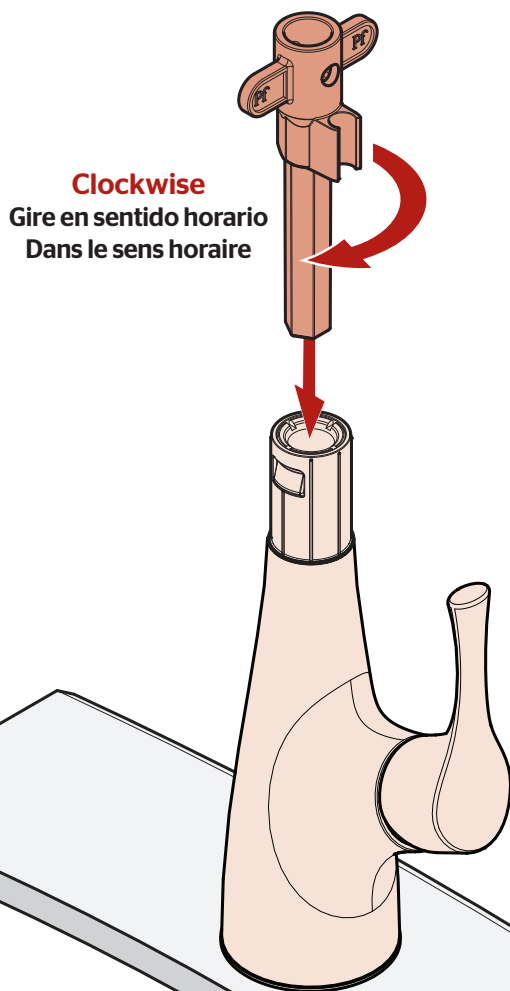

**Clockwise**  
Gire en sentido horario  
Dans le sens horaire



#### Tip • Consejo • Conseil

##### Use a drill to help turn tool faster (3/8" socket adapter).

Use un taladro para ayudar a girar la herramienta más rápido (adaptador de dado de 3/8 de pulgadas).

Utilisez un foreuse pour accélérer l'outil (adaptateur à douille de 3/8 po).

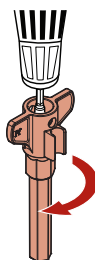

##### After drilling hand tighten to completely secure.

Deberá apretar a mano para asegurar completamente.  
Vous devrez serrer à la main pour sécuriser complètement.



#### OR • O • OU

#### Tip • Consejo • Conseil

##### Use a screwdriver to help turn tool faster.

Use un destornillador para ayudar a girar la herramienta más rápido.

Utilisez un tournevis pour accélérer l'outil.

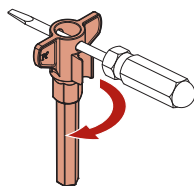

### 3B

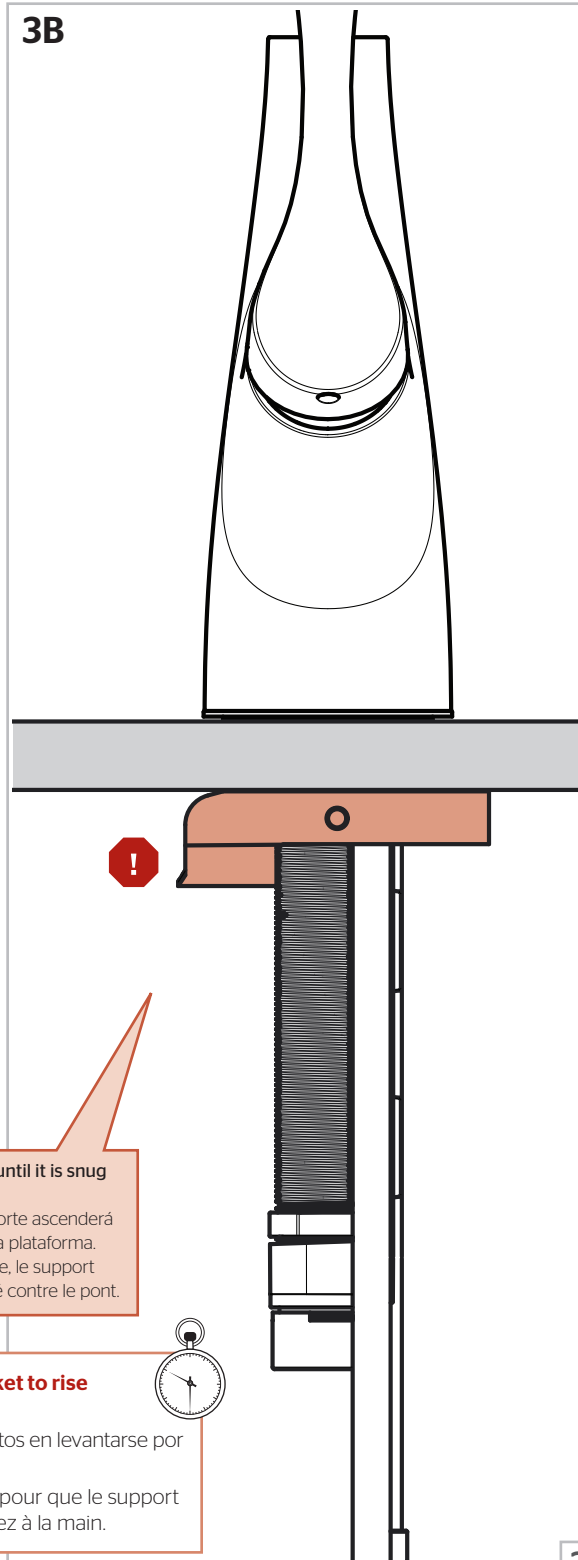

##### As tool turns bracket will ascend until it is snug against the deck.

Cuando la herramienta gire, el soporte ascenderá hasta que quede ajustado contra la plataforma.  
Au fur et à mesure que l'outil tourne, le support monte jusqu'à ce qu'il soit bien calé contre le pont.

##### Ensure bracket is now horizontal

Asegúrese de que el soporte esté ahora horizontal

Assurez-vous que le support est maintenant horizontal



##### it may take a few minutes for bracket to rise completely, if tightening by hand.

El soporte puede demorar unos minutos en levantarse por completo, si se aprieta con la mano.

Cela peut prendre quelques minutes pour que le support se lève complètement, si vous le serrez à la main.



# 4

## Prepare Spout for Installation

Prepare el surtidor para la instalación

Préparez le bec pour l'installation

*No Tools Required for This Step  
No se necesitan herramientas para este paso  
Pas d'outil nécessaire pour cette étape*

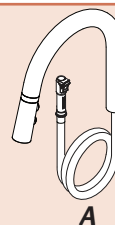

### Disassemble the Quick Connect

Desensamble el Quick Connect

Démontez le Quick Connect

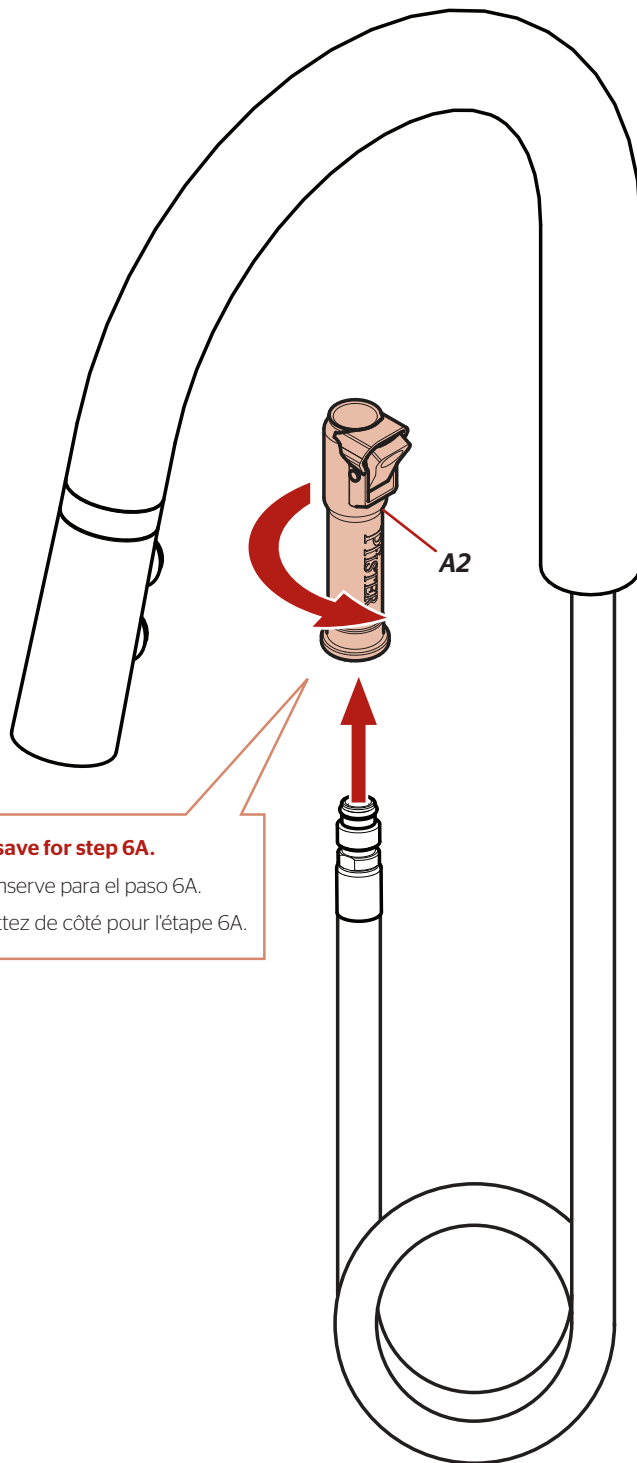

**Remove and save for step 6A.**

Remueva y conserve para el paso 6A.

Enlevez et mettez de côté pour l'étape 6A.

**5**

**Install Spout**  
**Instale el surtidor**  
**Installez le bec**

*No Tools Required for This Step*  
*No se necesitan herramientas para este paso*  
*Pas d'outil nécessaire pour cette étape*

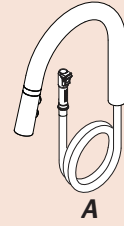

**Feed Hose through Spout Body**

**Alimentar la manguera a través del cuerpo del canalón**  
**Tuyau d'alimentation à travers le corps du bec**

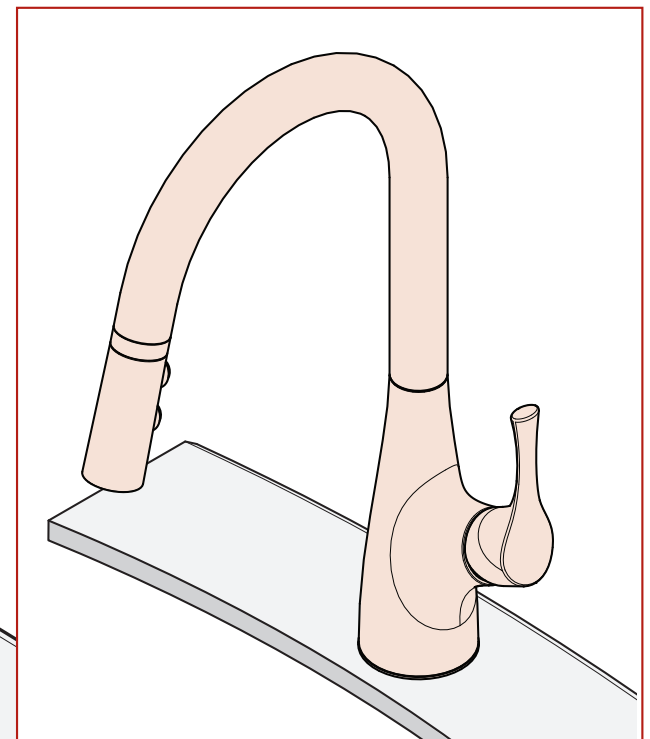
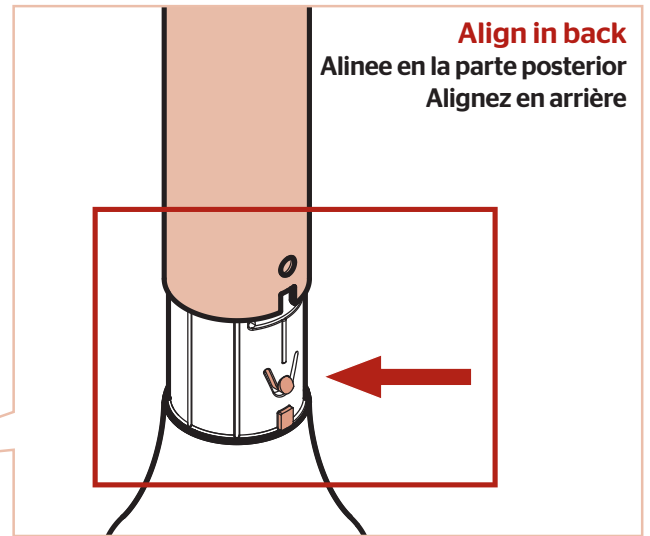
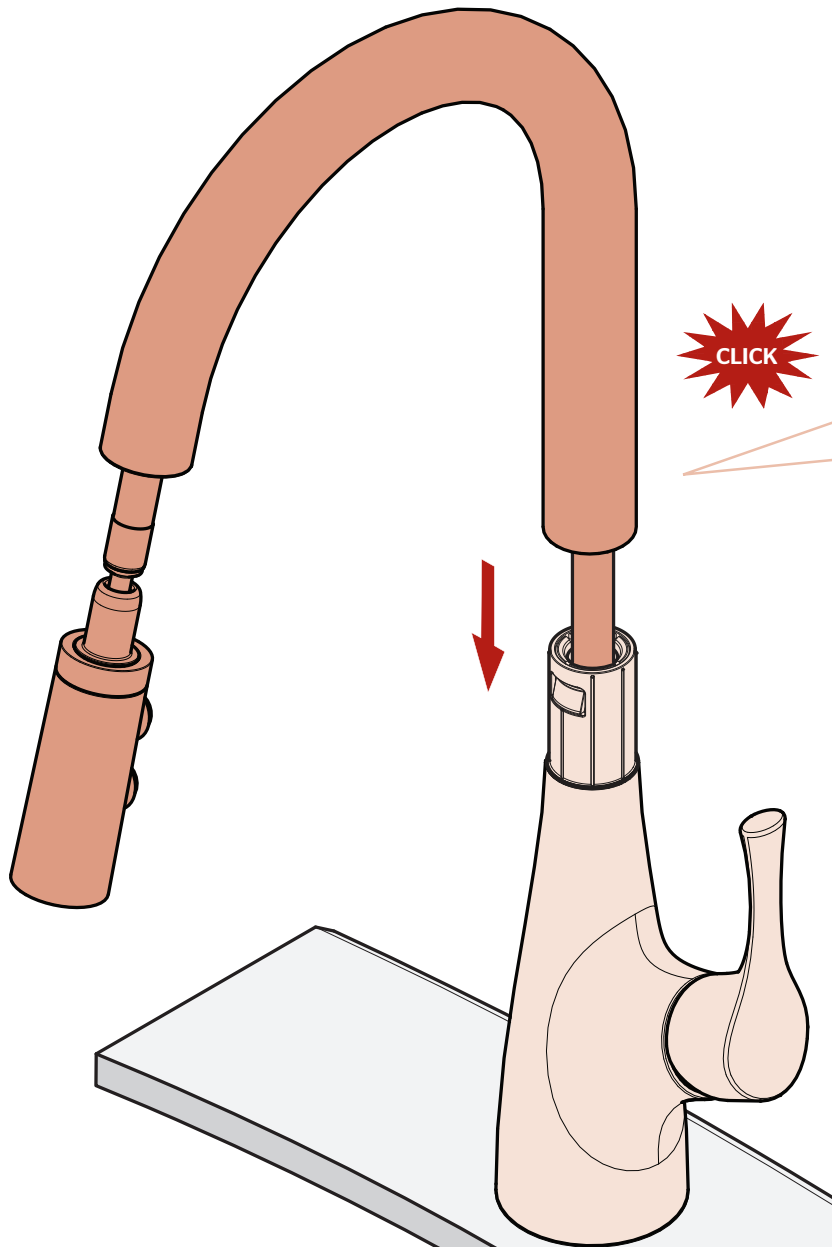

## 6 Install Weight and Connector to Hose Instale el peso y el conector a la manguera Installez le poids et le connecteur pour tuyau flexible

No Tools Required for This Step  
 No se necesitan herramientas para este paso  
 Pas d'outil nécessaire pour cette étape



F



A2

From Step 4.  
 Desde el paso 4.  
 De l'étape 4.

6A

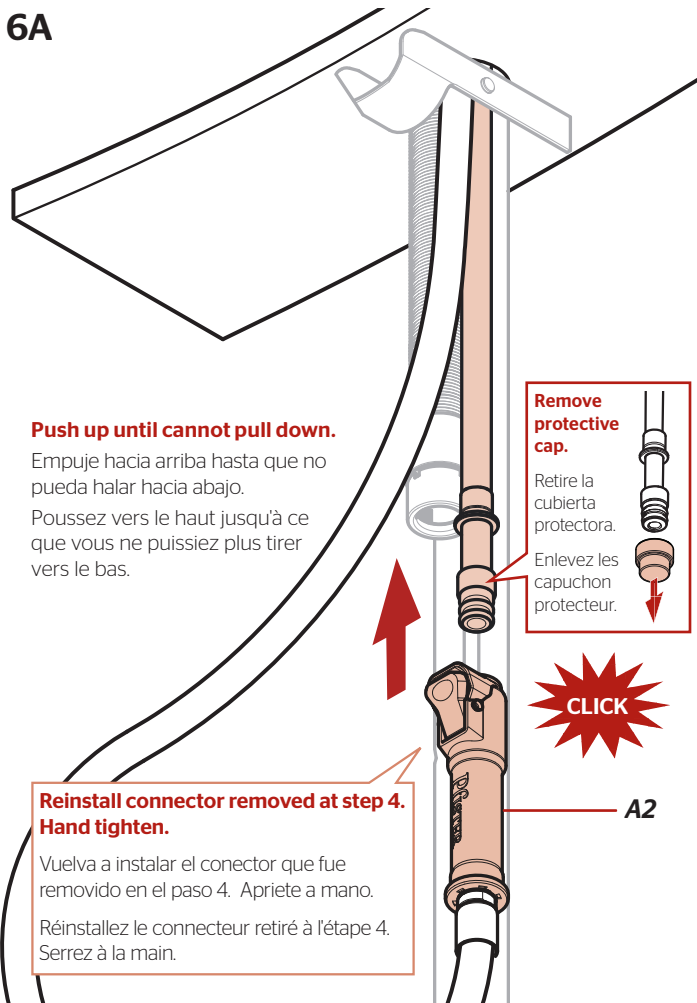

6B

### Disassemble weight

Desmontar peso  
 Démontez le poids

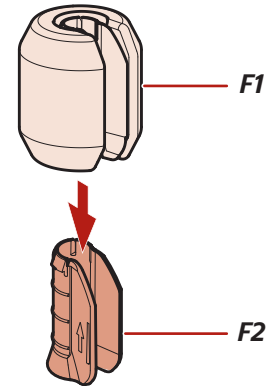

6C

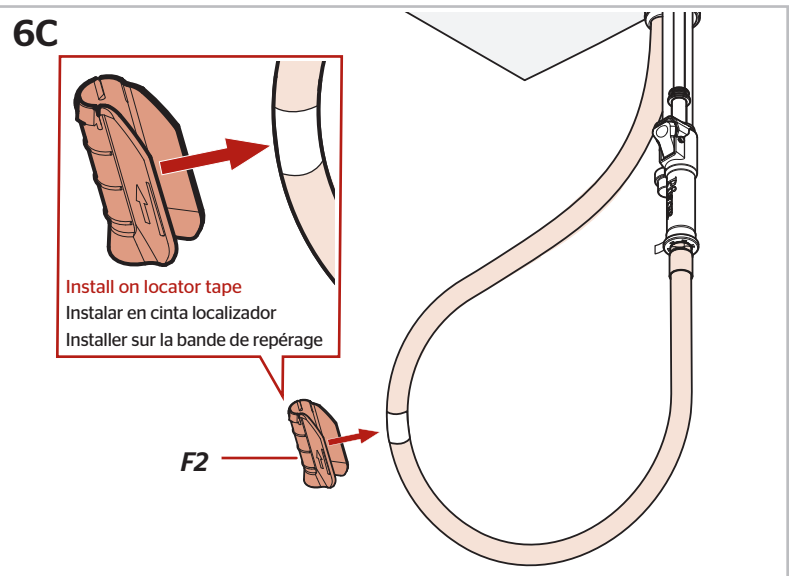

6D

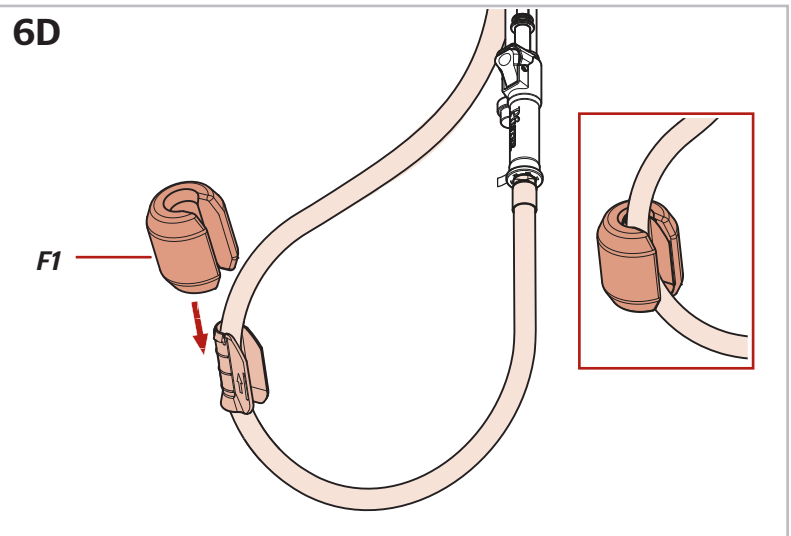

### Tip • Consejo • Conseil

#### Attach tool to the PERT line for easy storage.

Acople la herramienta a la línea PERT para un fácil almacenamiento.  
 Attachez l'outil à la ligne PERT pour un rangement facile.

## 7

## Connect Water Supply Lines

Conecte las tuberías de suministro de agua

Raccordez les conduites d'alimentation



Adjustable Wrench  
Llave ajustable  
Clé réglable

No Parts Required for This Step  
No se necesitan piezas para este paso  
Aucune pièce nécessaire pour cette étape

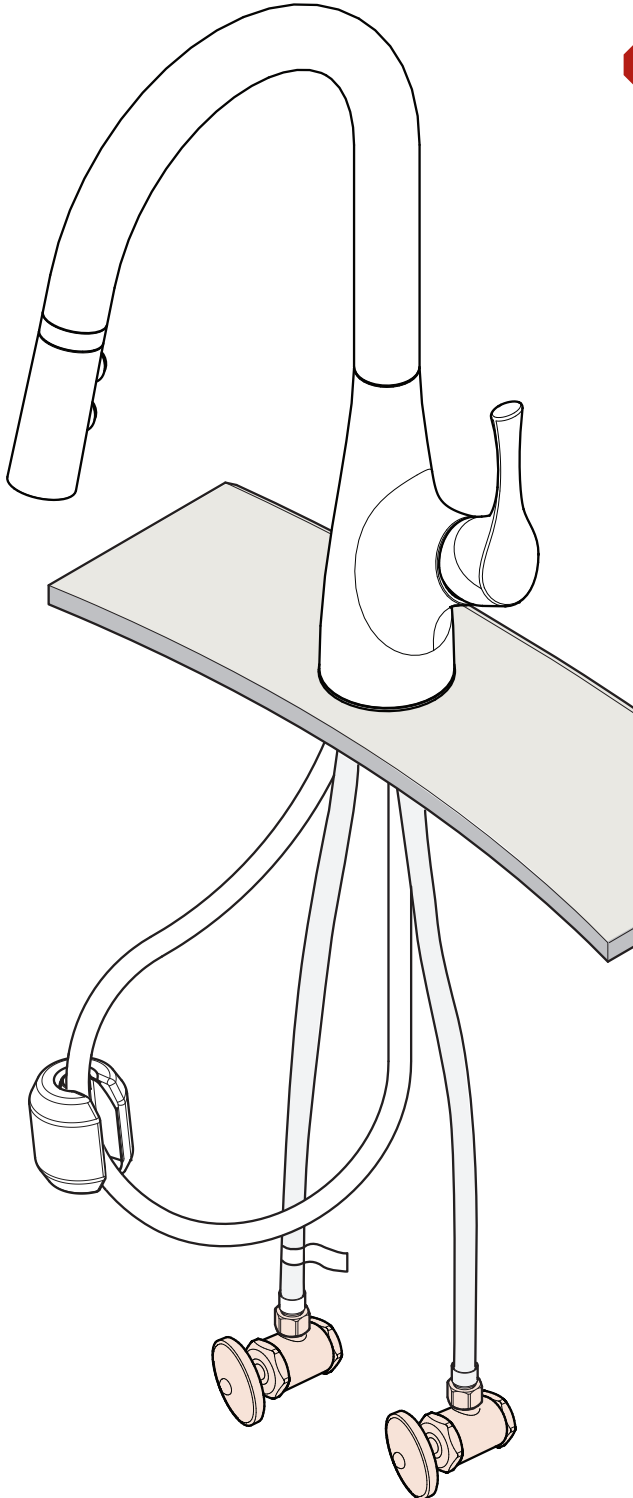

**Hot water supply line connects to left inlet indicated by red clip (tag side).  
Cold water supply line connects to right inlet indicated by blue clip.**

**NOTE: Incorrect application of supply lines and fittings may result in the failure or leak of the supply lines and fitting.**

La línea de suministro de agua caliente se conecta a la entrada izquierda indicada por la pestaña (lado de la pestaña).

La línea de suministro de agua fría se conecta a la entrada derecha.

**NOTA:** La colocación incorrecta de las líneas de suministro y dispositivos de sujeción puede ocasionar falla o fuga en las líneas de suministro y dispositivos de sujeción.

La conduite d'alimentation d'eau chaude se branche au robinet d'entrée gauche indiqué par l'étiquette (côté à étiquette).

La conduite d'alimentation d'eau froide se branche au robinet d'entrée droit.

**REMARQUE :** REMARQUE : L'application incorrecte des conduites d'alimentation et des raccords peut causer la défaillance ou des fuites au niveau des conduites d'alimentation et des raccords.

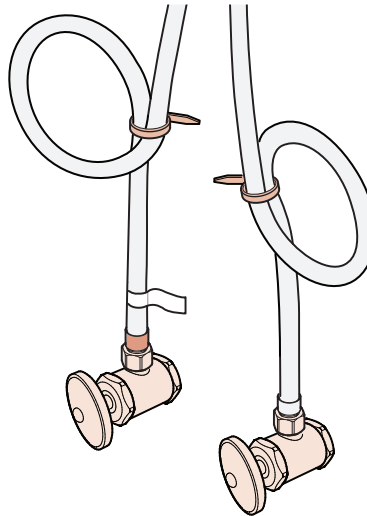

**Loop & secure if necessary.**

Recoja en forma de lazo y asegure de ser necesario.

La boucle et fixent au besoin.

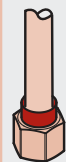

**3/8 inch female connection. Adapter may be required (not supplied).**

Conector hembra de 3/8 de pulgada. Se puede requerir de un adaptador (no se suministra).

Raccord femelle 3/8 de pouce. Adaptateur peut être nécessaire (non fourni).

x2

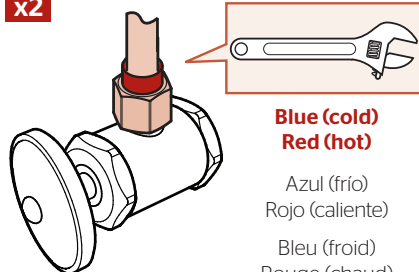

**Blue (cold)  
Red (hot)**

Azul (frío)  
Rojo (caliente)

Bleu (froid)  
Rouge (chaud)

# 8 Install Soap Dispenser

## Instale el dispensador de jabón

### Installez le distributeur de savon

No Tools Required for This Step  
 No se necesitan herramientas para este paso  
 Pas d'outil nécessaire pour cette étape

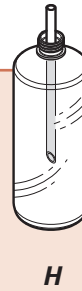
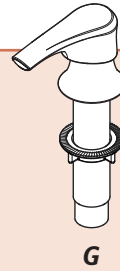

### 8A Disassemble Desensamble Démontez

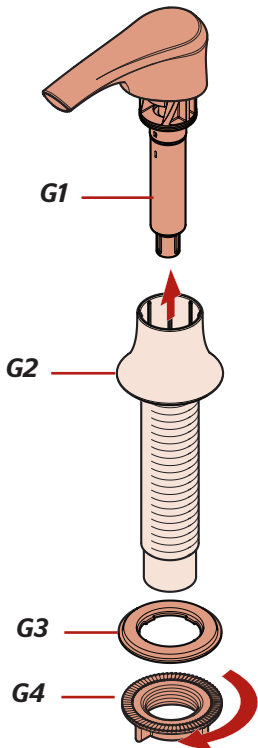

### 8B

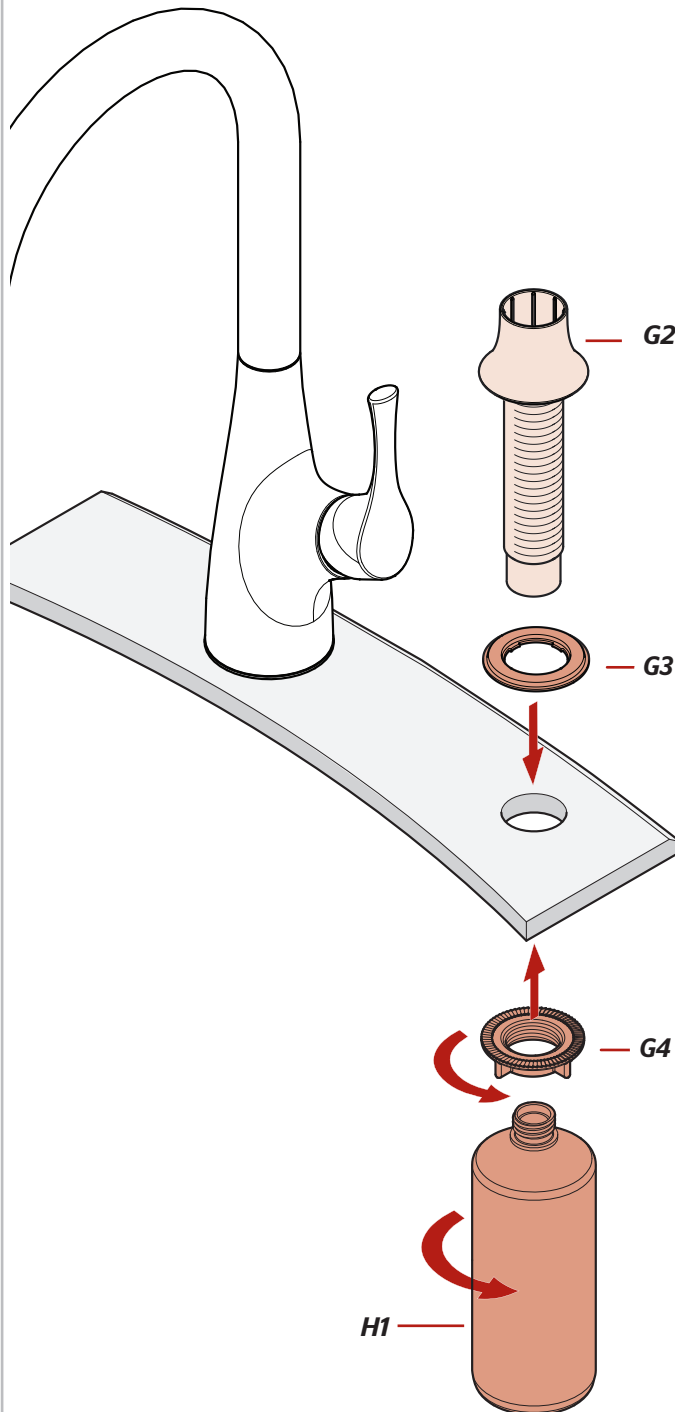

### 8C

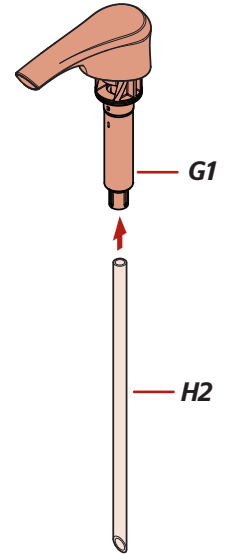

### 8D

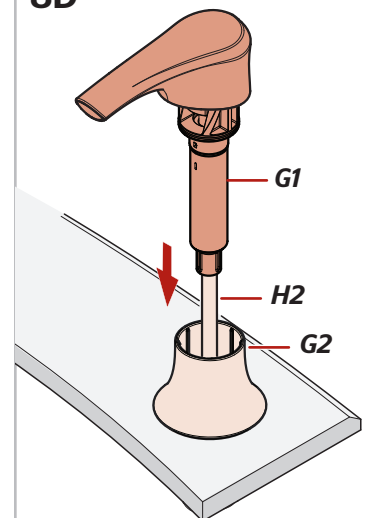



**9 Turn On Water & Confirm Proper Installation**  
**Active el suministro de agua y confirme si la instalación es la apropiada**  
**Ouvrez l'eau et vérifiez que l'installation est adéquate**

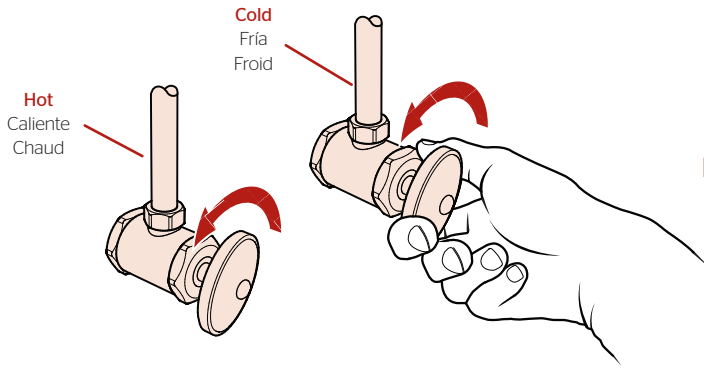

**!** **Check for leaks above and below the sink.**  
 Revise si hay fugas encima y debajo del fregadero.  
 Assurez-vous qu'il n'y a pas de fuite au dessus et au dessous de l'évier.

**10 Flush the Faucet**  
**Purgue el grifo**  
**Vidangez le robinet**



Aerator Tool  
 Herramienta para el aireador  
 Outil d'aérateur

*No Parts Required for This Step*  
*No se necesitan piezas para este paso*  
*Aucune pièce nécessaire pour cette étape*

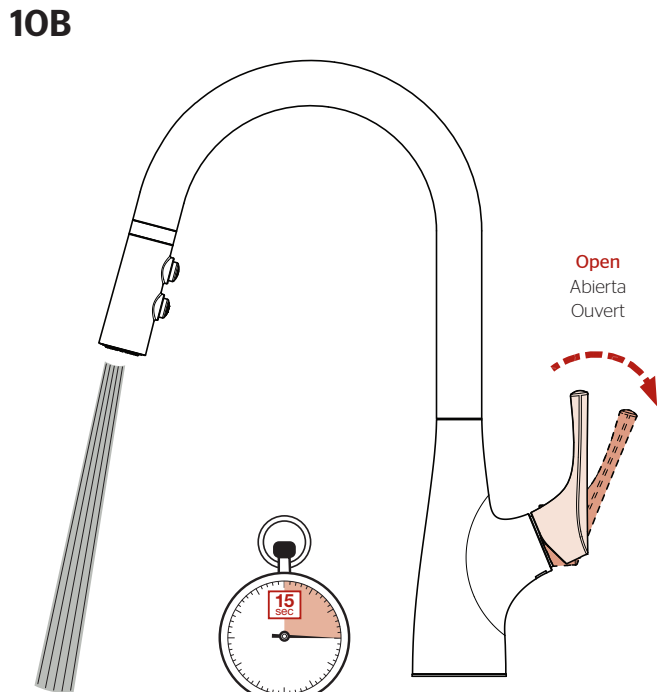
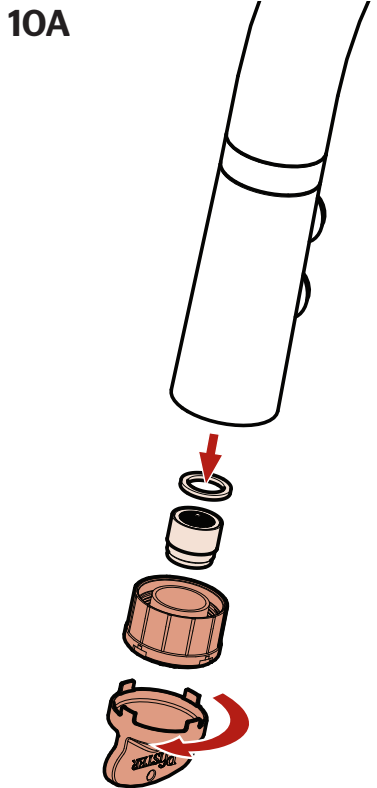

**Allow full hot & full cold water to run for at least 15 seconds each.**  
 Deje correr el agua caliente y fría durante al menos 15 segundos cada una.  
 Laissez de l'eau chaude et de l'eau froide couler à plein débit pendant au moins 15 secondes chacune.

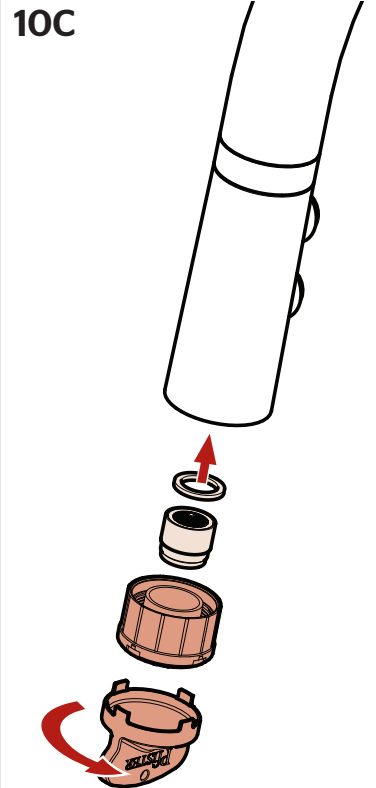

## Faucet Functions

### Funciones del grifo

### Fonctions du robinet

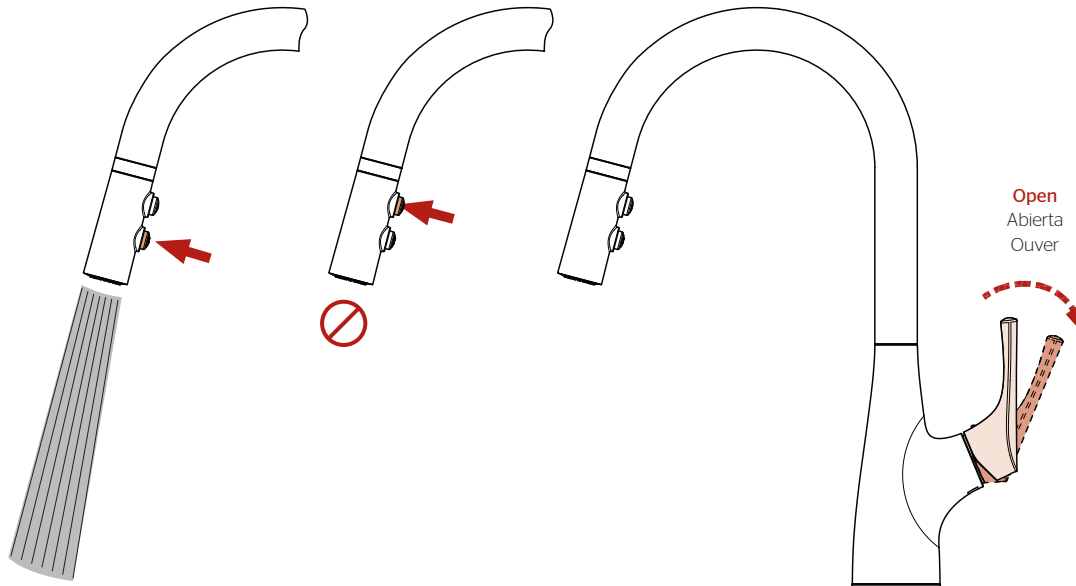

**Hold the top button to pause the water.**

**Press the lower button to enter spray mode. Press lower button again to return to stream mode.**

**Note: The faucet will always turn on in regular stream mode.**

Mantenga presionado el botón superior para pausar el agua.

Presione el botón inferior para ingresar al modo de rociado. Pulse el botón inferior de nuevo para volver al modo de transmisión.

**Nota:** El grifo siempre se abrirá en el modo de flujo continuo.

Maintenez le bouton du haut pour mettre l'eau en pause.

Appuyez sur le bouton du bas pour passer en mode pulvérisation. Appuyez à nouveau sur le bouton inférieur pour revenir au mode flux.

**Remarque :** Le robinet s'ouvre toujours en mode flux régulier.

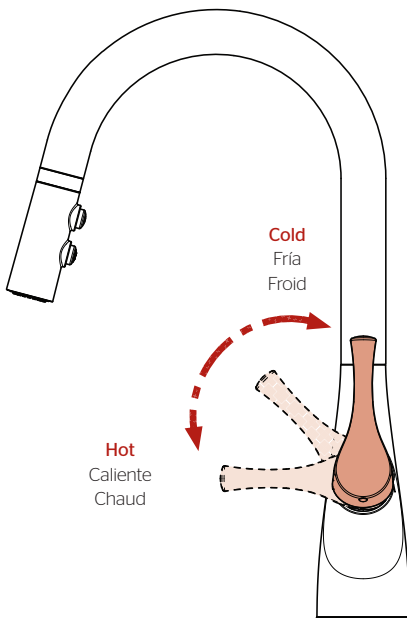

**One-Handed Operation**  
Operación con un mano  
Opération avec une main

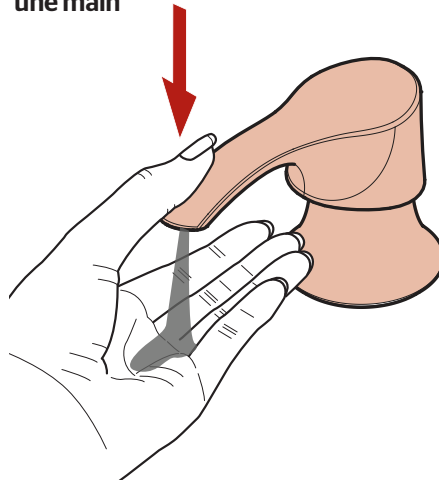

**Two-Handed Operation**  
Operación con dos manos  
Opération avec deux mains

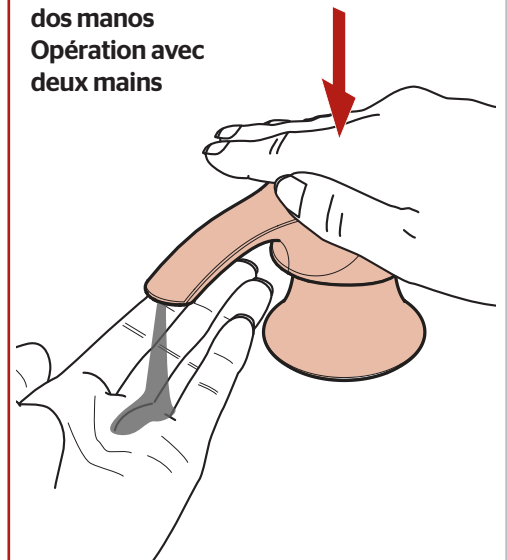

For Additional Installation Help:  
Para adicional ayuda:  
Pour aider à l'installation supplémentaires:

**Pfister**

1-800-PFAUCET (732-8238)  
pfisterfaucets.com